

HIGH FEED MILLING CUTTERS

UD90

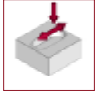

NEWTool

The versions with \varnothing 16–50 mm are optimal for powerful milling on live tooling lathes and machining centers with rather low rigidity and drive power

DIN tool holders with standard adaptation shank and spindle connection for HSK, Capto and SK

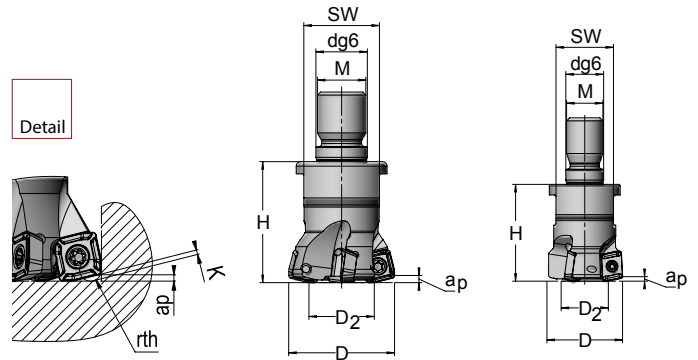

UD90 Screw-in milling cutters														INS
Article	D	D ₂	dg ₆	H	M	SW	z _{eff}	a _p	rth	K	Ramp	lc	kg	
18U.1625.130	16	6.6	8.5	25	8	12	2	1.0	1.5	0.7	3°	yes	0.05	UD..0602.R*
18U.2025.130	20	10.6	10.5	25	10	15	2	1.0	1.5	0.7	3°	yes	0.05	UD..0602.R
18U.2532.130	25	15.6	12.5	32	12	19	3	1.0	1.5	0.7	3°	yes	0.10	UD..0602.R
18U.2532.080	25	14.6	12.5	32	12	17	2	1.3	2.1	0.8	4°	yes	0.10	UD..0803.R
18U.3240.130	32	22.6	17	40	16	27	4	1.0	1.5	0.7	2.5°	yes	0.21	UD..0602.R
18U.3240.080	32	21.7	17	40	16	25	4	1.3	2.1	0.8	2.8°	yes	0.18	UD..0803.R
18U.3240.100	32	18.6	17	40	16	25	3	1.7	2.5	1.0	3.5°	yes	0.19	UD..10T3.R
18U.3540.130	35	25.6	17	40	16	30	5	1.0	1.5	0.7	2.5°	yes	0.25	UD..0602.R
18U.3540.080	35	24.7	17	40	16	27	4	1.3	2.1	0.8	2.5°	yes	0.22	UD..0803.R
18U.3540.100	35	21.6	17	40	16	25	4	1.7	2.5	1.0	2.9°	yes	0.20	UD..10T3.R
18U.3540.070	35	19.6	17	40	16	30	3	2.0	2.5	1.3	3.8°	yes	0.25	UD..1204.R
18U.4040.130	40	30.6	17	40	16	32	5	1.0	1.5	0.7	2.0°	yes	0.32	UD..0602.R
18U.4040.080	40	27.2	17	40	16	30	5	1.3	2.1	0.8	2.3°	yes	0.26	UD..0803.R
18U.4040.100	40	26.6	17	40	16	30	4	1.7	2.5	1.0	2.5°	yes	0.27	UD..10T3.R
18U.5040.070	50	34.6	17	40	16	30	5	2.0	2.5	1.3	3.0°	yes	0.36	UD..1204.R*

* Note that the screw length required varies depending on the insert used

HIGH FEED MILLING CUTTERS

UD90

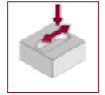

NEWTool



Suitable for universal use, with 2- and 4-cutting edge UDGT indexable insert, in particular for high alloy steels
 "Soft" cutting ensures maximum metal removal rate Q even in case of extreme overhang – ideal for pocket milling
 Remarkable finishing quality even at high feed rates – excellent surface quality

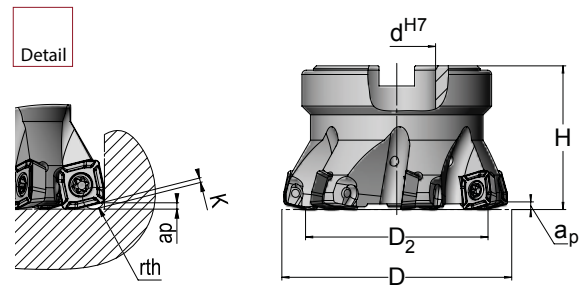

UD90 Plug-in milling cutters												
Article	D	D ₂	d ^{H7}	H	Z _{eff}	a _p	rth	K	Ramp	Ic	kg	INS
18U.5050.100	50	36.6	22	50	6	1.7	2.5	1.0	2.1°	yes	0.38	UD..10T3.R
18U.5050.070	50	34.6	22	50	5	2.0	2.5	1.3	3.0°	yes	0.36	UD..1204.R*
18U.5250.100	52	38.6	22	50	6	1.7	2.5	1.0	1.9°	yes	0.40	UD..10T3.R
18U.5250.070	52	36.6	22	50	5	2.0	2.5	1.3	3.0°	yes	0.42	UD..1204.R*
18U.6350.100	63	49.6	22	50	7	1.7	2.5	1.0	1.6°	yes	0.65	UD..10T3.R
18U.6350.070	63	47.6	22	50	6	2.0	2.5	1.3	2.0°	yes	0.62	UD..1204.R
18U.6650.100	66	52.6	27	50	7	1.7	2.5	1.0	1.5°	yes	0.65	UD..10T3.R
18U.6650.070	66	50.6	27	50	6	2.0	2.5	1.3	1.8°	yes	0.67	UD..1204.R
18U.8050.070	80	64.6	27	50	7	2.0	2.5	1.3	1.3°	yes	1.03	UD..1204.R
18U.8050.160	80	56.2	27	50	5	3.0	3.8	3.0	1.1°	yes	0.94	UD..1606.R
18U.1050.070	100	84.6	32	50	9	2.0	2.5	1.3	1.2°	yes	1.57	UD..1204.R
18U.1050.160	100	76.2	32	50	7	3.0	3.8	3.0	1.1°	yes	1.57	UD..1606.R
18U.1263.070	125	109.6	40	63	11	2.0	2.5	1.3	0.8°	yes	3.14	UD..1204.R
18U.1263.160	125	98.6	40	63	9	3.0	3.8	3.0	1.1°	yes	3.10	UD..1606.R
18U.1663.160**	160	136.2	40	63	10	3.0	3.8	3.0	0.8°	yes	5.73	UD..1606.R

* Note that the screw length required varies depending on the insert used

** On request

INS SHAPE UD

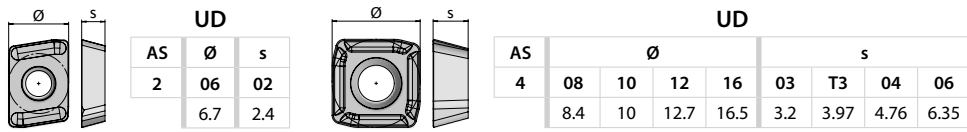

Matching of machining parameters with the AV material groups

				Steel						
Article		Designation		A22	A21	A20	A19	A18	A17	A16
UD.0602..	UD.0602.002.01 SKY77	UDGT 060215 SR-28	f _z	1.10	1.00	0.85	0.80	0.80	0.70	0.60
			v _c	280-320	240-280	210-240	180-210	140-180	110-140	70-110
	UD.0602.002.01 AV1044	UDGT 060215 SR-28	f _z	-	-	0.85	0.80	0.80	0.70	0.60
			v _c	-	-	230-290	190-240	170-200	140-180	90-130
	UD.0602.002.01 AV1055	UDGT 060215 SR-28	f _z	-	-	-	0.80	0.80	0.70	0.60
			v _c	-	-	-	190-240	170-200	140-180	90-130
UD.0803..	UD.0803.003.01 SKY77	UDGT 080321 SR-28	f _z	1.30	1.15	1.00	1.00	1.00	0.80	0.60
			v _c	280-320	240-280	210-240	180-210	140-180	110-140	70-110
	UD.0803.003.01 AV1044	UDGT 080321 SR-28	f _z	-	-	1.00	1.00	1.00	0.80	0.60
			v _c	-	-	230-290	190-240	170-200	140-180	90-130
	UD.0803.003.01 AV1055	UDGT 080321 SR-28	f _z	-	-	-	1.00	1.00	0.80	0.60
			v _c	-	-	-	190-240	170-200	140-180	90-130
UD.10T3..	UD.10T3.002.01 SKY77	UDGT 10T325 SR-25	f _z	1.40	1.30	1.20	1.20	1.20	0.90	0.65
			v _c	280-320	240-280	210-240	180-210	140-180	110-140	70-110
	UD.10T3.002.01 AV1077	UDGT 10T325 SR-25	f _z	1.40	1.30	1.20	1.20	1.20	0.90	0.65
			v _c	290-340	260-300	220-250	190-230	150-210	130-170	80-120
	UD.10T3.002.02 AV1044	UDGT 10T325 SR-28	f _z	-	-	1.20	1.20	1.20	0.90	0.65
			v _c	-	-	230-290	190-240	170-200	140-180	90-130
UD.10T3.002.02 AV1055	UDGT 10T325 SR-28	f _z	-	-	-	1.20	1.20	0.90	0.65	
		v _c	-	-	-	190-240	170-200	140-180	90-130	
UD.1204..	UD.1204.002.01 SKY77	UDGT 120425 SR-25	f _z	1.70	1.50	1.40	1.40	1.40	1.00	0.70
			v _c	280-320	240-280	210-240	180-210	140-180	110-140	70-110
	UD.1204.002.01 AV1077	UDGT 120425 SR-25	f _z	1.70	1.50	1.40	1.40	1.40	1.00	0.70
			v _c	290-340	260-300	220-250	190-230	150-210	130-170	80-120
	UD.1204.002.02 AV1044	UDGT 120425 SR-28	f _z	-	-	1.40	1.40	1.40	1.00	0.70
			v _c	-	-	230-290	190-240	170-200	140-180	90-130
UD.1204.002.02 AV1055	UDGT 120425 SR-28	f _z	-	-	-	1.40	1.40	1.00	0.70	
		v _c	-	-	-	190-240	170-200	140-180	90-130	
UD.1606..	UD.1606.002.01 SKY77	UDGT 160638 SR-25	f _z	2.00	1.80	1.60	1.60	1.60	1.20	0.80
			v _c	280-320	240-280	210-240	180-210	140-180	110-140	70-110
	UD.1606.002.01 AV1077	UDGT 160638 SR-25	f _z	2.00	1.80	1.60	1.60	1.60	1.20	0.80
			v _c	290-340	260-300	220-250	190-230	150-210	130-170	80-120
	UD.1606.002.02 AV1044	UDGT 160638 SR-28	f _z	-	-	1.60	1.60	1.60	1.20	0.80
			v _c	-	-	230-290	190-240	170-200	140-180	90-130
UD.1606.002.02 AV1055	UDGT 160638 SR-28	f _z	-	-	-	1.60	1.60	1.20	0.80	
		v _c	-	-	-	190-240	170-200	140-180	90-130	

INS SHAPE UD

UD			UD							
AS	Ø	s	Ø				s			
2	06	02	08	10	12	16	03	T3	04	06
	6.7	2.4	8.4	10	12.7	16.5	3.2	3.97	4.76	6.35

Matching of machining parameters
with the AV material groups

				Cast iron					
Article		Designation		D21	D20	D19	D18	D17	D16
UD.0602..	UD.0602.002.01 SKY77	UDGT 060215 SR-28	f _z	1.20	1.10	0.95	0.80	0.60	0.60
			v _c	290-340	260-310	240-280	210-240	180-210	140-180
UD.0803..	UD.0803.003.01 SKY77	UDGT 080321 SR-28	f _z	1.40	1.20	1.00	1.00	0.80	0.70
			v _c	290-340	260-310	240-280	210-240	180-210	140-180
UD.10T3..	UD.10T3.002.01 SKY77	UDGT 10T325 SR-25	f _z	1.50	1.40	1.20	1.20	1.00	0.75
			v _c	290-340	260-310	240-280	210-240	180-210	140-180
UD.1204..	UD.1204.002.01 SKY77	UDGT 120425 SR-25	f _z	1.80	1.60	1.40	1.40	1.20	0.90
			v _c	290-340	260-310	240-280	210-240	180-210	140-180
UD.1606..	UD.1606.002.01 SKY77	UDGT 160638 SR-25	f _z	2.10	1.90	1.60	1.60	1.40	1.00
			v _c	290-340	260-310	240-280	210-240	180-210	140-180



				Stainless steels				Titanium		
Article		Designation		C12	C11	C10	C09	S10	S09	S08
UD.0602..	UD.0602.002.01 SKY77	UDGT 060215 SR-28	f _z	0.80	-	-	-	-	-	-
			v _c	100-150	-	-	-	-	-	-
	UD.0602.002.01 AV1044	UDGT 060215 SR-28	f _z	0.80	0.75	0.70	-	-	-	-
			v _c	100-150	140-170	100-140	-	-	-	-
	UD.0602.002.01 AV1055	UDGT 060215 SR-28	f _z	0.80	0.75	0.70	0.50	0.70	0.50	0.45
			v _c	120-200	140-170	100-140	60-100	60-80	40-70	20-50
UD.0803..	UD.0803.003.01 SKY77	UDGT 080321 SR-28	f _z	0.80	-	-	-	-	-	-
			v _c	100-150	-	-	-	-	-	-
	UD.0803.003.01 AV1044	UDGT 080321 SR-28	f _z	0.80	0.75	0.70	-	-	-	-
			v _c	100-170	100-170	100-140	-	-	-	-
	UD.0803.003.01 AV1055	UDGT 080321 SR-28	f _z	0.80	0.75	0.70	0.55	0.70	0.50	0.45
			v _c	120-200	100-170	100-140	60-100	60-80	40-70	20-50
UD.10T3..	UD.10T3.002.01 SKY77	UDGT 10T325 SR-25	f _z	0.90	-	-	-	-	-	-
			v _c	100-150	-	-	-	-	-	-
	UD.10T3.002.01 AV1077	UDGT 10T325 SR-25	f _z	0.90	0.80	-	-	-	-	-
			v _c	100-150	100-150	-	-	-	-	-
	UD.10T3.002.02 AV1044	UDGT 10T325 SR-28	f _z	0.90	0.80	0.75	-	-	-	-
			v _c	100-170	100-170	100-140	-	-	-	-
UD.10T3.002.02 AV1055	UDGT 10T325 SR-28	f _z	0.90	0.80	0.75	0.60	0.70	0.60	0.45	
		v _c	100-200	100-170	100-140	60-100	60-80	40-70	20-50	

INS SHAPE UD

UD				UD							
AS	Ø	s		Ø				s			
2	06	02		08	10	12	16	03	T3	04	06
	6.7	2.4		8.4	10	12.7	16.5	3.2	3.97	4.76	6.35

Matching of machining parameters with the AV material groups

Article	Designation		Stainless steels				Titanium				
			C12	C11	C10	C09	S10	S09	S08		
UD.1204..	UD.1204.002.01 SKY77	UDGT 120425 SR-25	f _z	1.00	-	-	-	-	-	-	
			v _c	100-150	-	-	-	-	-	-	
	UD.1204.002.01 AV1077	UDGT 120425 SR-25	f _z	1.00	0.85	0.75	-	-	-	-	
			v _c	100-150	100-150	100-140	-	-	-	-	
UD.1204.002.02 AV1044	UDGT 120425 SR-28	UDGT 120425 SR-28	f _z	1.00	0.85	0.75	-	-	-	-	
			v _c	100-170	100-170	100-140	-	-	-	-	
	UD.1204.002.02 AV1055	UDGT 120425 SR-28	f _z	1.00	0.85	0.75	0.60	0.70	0.60	0.45	
			v _c	120-200	100-170	100-140	60-100	60-80	40-70	20-50	
UD.1606..	UD.1606.002.01 SKY77	UDGT 160638 SR-25	f _z	1.20	-	-	-	-	-	-	
			v _c	100-150	-	-	-	-	-	-	
	UD.1606.002.01 AV1077	UDGT 160638 SR-25	f _z	1.20	0.90	0.80	-	-	-	-	
			v _c	100-150	100-150	100-140	-	-	-	-	
	UD.1606.002.02 AV1044	UDGT 160638 SR-28	UDGT 160638 SR-28	f _z	1.20	0.90	0.80	-	-	-	-
				v _c	100-170	100-170	100-140	-	-	-	-
		UD.1606.002.02 AV1055	UDGT 160638 SR-28	f _z	1.20	0.90	0.80	0.70	0.75	0.70	0.50
				v _c	120-200	100-170	100-140	60-100	60-80	40-70	20-50

INS		
UD..0602...*	08TP.2555.500	TP711
UD..0602...	08TP.2565.501	TP711
UD..0803...	08B.0307.7991	TX208
UD..10T3...	08B.3509.7991	TX215
UD..1204...*	08B.0409.7991	TX215
UD..1204...	08B.0411.7991	TX215
UD..1606...	08B.0513.7991	TX220

* Note that the screw length required varies depending on the insert used